

## LUG/S

Reposamaleta plegable de metal con respaldo. Material de la estructura: metal con perfil redondo. Material de las correas: cuero real, disponible en diferentes colores. Acabado de la estructura: metálico (acero o latón) o pintado en los colores Apir o en cualquier color de la escala RAL. Pies de goma. Estructura plegable para minimizar el volumen. Altura abierto: 72 cm Altura cerrado: 91 cm Anchura: 60,5 cm Profundidad abierto: 53,5 cm Peso: 3,7 kg

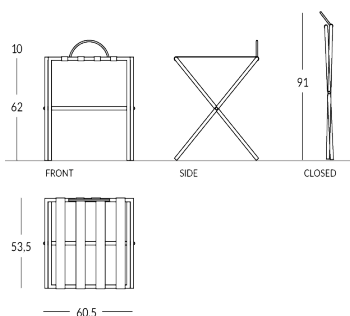

### Versione



## Finiture Metalliche | Metal finishes | Finitions métalliques

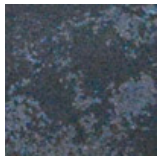

Acero industrial



Acero brillante



Acero satinado

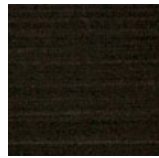

Latón Envejecido Oscuro



Latón bronce claro



Latón bronce oscuro

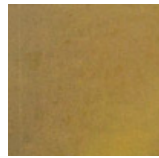

Latón industrial



Latón brillante.



Latón satinado.



Cobre satinado efecto antiguo opaco



Cobre satinado brillante

## Finiture Verniciate | Painted finishes | Finitions peintes

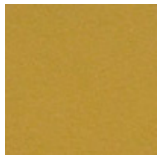

Oro

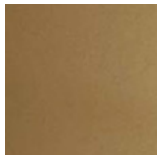

Oro antiguo

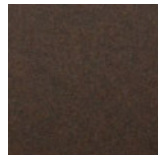

Bronze

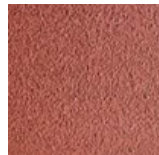

Simil Corten

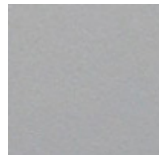

Silver



Tortora (Ral 1019)

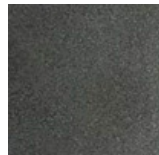

Canna di Fucile

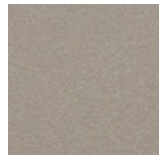

Antiguo De Luz

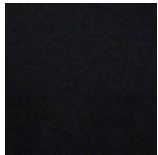

Matt black (Ral 9005)



Polished black (Ral 9005)

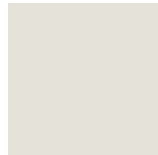

Matt white (Ral 9010)



Gris oscuro (Ral 7016)



Gris claro (Ral 7042)



Ral

## Colore Cinghie | Strap colour | Couleur de courroies

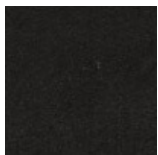

Cuero negro

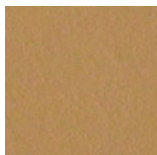

Cuero

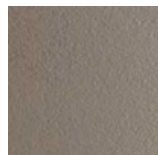

Cuero Barro

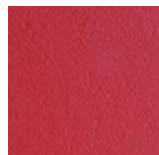

Cuero Rojo

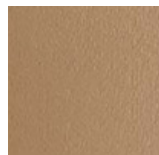

Cuero Topo

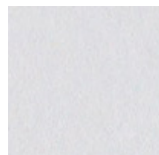

Cuero blanco

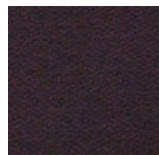

Cuero marrón oscuro